

RAEPoint

User's Guide



RAEPoint User's Guide

Special Servicing Note

If the instrument needs to be serviced, contact either:
The RAE Systems distributor from whom the instrument was purchased; they will return the instrument on your behalf.

or

The RAE Systems Technical Service Department. Before returning the instrument for service or repair, obtain a Returned Material Authorization (RMA) number for proper tracking of your equipment. This number needs to be on all documentation and posted on the outside of the box in which the instrument is returned for service or upgrade. Packages without RMA Numbers will be refused at the factory.



© Copyright 2014 RAE Systems by Honeywell.

RAEPoint User's Guide

Contents

WARNINGS.....	1
1 General Information	2
2 Proper Product Disposal At End Of Life.....	3
3 FCC Part 15 Statement	3
4 Applications.....	4
5 RAEPoint Specifications	7
6 Operation	8
7 Physical Description	9
8 Physical Dimensions	9
9 Installation And Access Instructions	10
9.1 Mounting	10
9.2 Instrument Disassembly	12
9.3 Instrument Reassembly	13
10 RAEPoint Wiring	14
11 RAEPoint Wiring Procedure	15
12 DC Control Wiring.....	16
13 Switch Settings	17
13.1 Pan ID (SW1) And Channel (SW2)	17
13.2 Mode Switch (SW3)	18
13.3 Jumper JP1.....	19
14 Earth Grounding Instructions	20
14.1 External Earth Grounding.....	20
14.2 Internal Earth Grounding.....	20
14.3 Finished Grounding Wires	21
15 Display/User Interface.....	22
16 Alarm Signal Summary	22
16.1 RAEPoint Host	23
16.2 RAEPoint Remote	24
16.3 RAEPoint Router.....	25
17 Appendix A: Controlled Section	26
17.1 Scope	26
17.2 Responsibility	26
17.3 Contents.....	26
18 Technical Support.....	33
19 RAE Systems Contacts.....	33

RAEPoint User's Guide

Read Before Operating

This manual must be carefully read by all individuals who have or will have the responsibility of using, maintaining, or servicing this product. The product will perform as designed only if it is used, maintained, and serviced in accordance with the manufacturer's instructions. The user should understand how to set the correct parameters and interpret the obtained results.

CAUTION!

To reduce the risk of electric shock, turn the power off before opening this instrument or performing service. Never operate the instrument when the instrument is open. Use and service this product only in an area known to be non-hazardous.

WARNINGS

For safety reasons, this equipment must be operated and serviced by qualified personnel only. Read and understand instruction manual completely before operating or servicing.

AVERTISSEMENT

Pour des raisons de sécurité, cet équipement doit être utilisé, entretenu et réparé uniquement par un personnel qualifié. Étudier le manuel d'instructions en entier avant d'utiliser, d'entretenir ou de réparer l'équipement.

RAEPoint User's Guide

1 General Information

RAEPoint is an explosion-proof wireless device that both extends the range and enables remote relay functionality across a wireless mesh network. As part of a wireless mesh network, the RAEPoint communicates with wireless detectors and controllers and can direct any of its five internal relays to trigger audible and visible alarms. Remote alarm notifications are critical for many applications where local device alarms are simply not visible enough or loud enough to alert a wide area. RAEPoint relay settings can be fully configured wirelessly via the system controller. RAEPoint can also be configured as a wireless host, and communicate directly with detectors, providing a localized alarm notification solution that does not require a controller.

Key Features

- Five internal SPDT relays (except in RAEPoint router)
- Wireless transmission distance of 1000 ft (300m) line-of-sight. Range can be extended by using wireless routers.
- Class 1, Division 1, and IECEx/ATEX Zone 1 hazardous area certification
- Explosion-proof enclosure for hazardous environment applications
- LEDs indicate status

Applications

- Oil and gas exploration
- Refineries and petrochemical plants
- Fenceline monitoring

2 Proper Product Disposal At End Of Life



The Waste Electrical and Electronic Equipment (WEEE) directive (2002/96/EC) is intended to promote recycling of electrical and electronic equipment and their components at end of life. This symbol (crossed-out wheeled bin) indicates separate collection of waste electrical and electronic equipment in the EU countries.

3 FCC Part 15 Statement

This device complies with Part 15 of the FCC rules. Operation is subject to the following two conditions: (1) This device may not cause harmful interference, and (2) this device must accept any interference received, including interference that may cause undesired operation.

RAEPoint User's Guide

4 Applications

The RAEPoint can be ordered as a stand-alone wireless unit, or as part of an integrated Wireless Alarm Bar complete with 2 strobes and horn (Wireless Alarm Bar). Each RAEPoint can be configured as a Router, Remote, or Host on a wireless mesh network.

Note: The Wireless Alarm Bars (AC and DC versions) used as examples in this manual do not conform to the same certifications of the RAEPoint. Refer to the corresponding Wireless Alarm Bar manuals for product specific specifications.

RAEPoint Router

A stand-alone, DC-powered, explosion-proof unit that acts as a permanent wireless router for mesh network systems. Includes aluminum enclosure with LED status indicators and an integrated wireless mesh radio.

RAEPoint Remote & RAEPoint Host

Stand-alone relay units include aluminum enclosure with LED status indicators, an integrated wireless mesh radio, and five integrated relays.

RAEPoint Remote Wireless Alarm Bar & RAEPoint Host Wireless Alarm Bar

Wireless alarm bar units include the RAEPoint fully integrated with 2 certified xenon strobes and a certified 110dB horn.

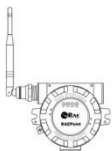

RAEPoint

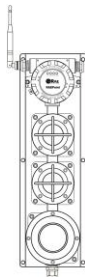

RAEPoint DC-Powered Wireless Alarm Bar

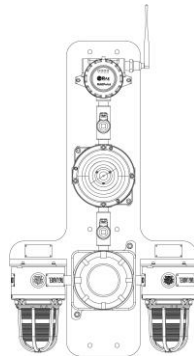

RAEPoint AC-Powered Wireless Alarm Bar

RAEPoint User's Guide

Flexibility

RAEPoint can be used in large or small systems, and the network can be expanded or units removed, depending on the facility or facilities being monitored.

Simple configurations that use MeshGuard sensors and a RAEPoint Wireless Alarm Bar host

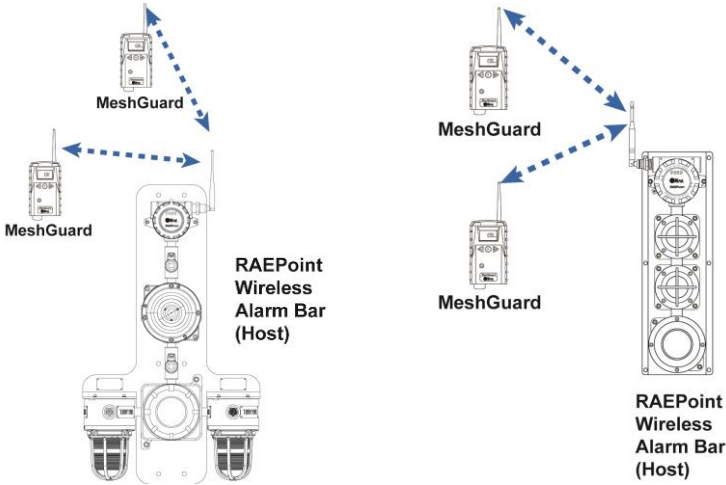

Full network, including externally controlled devices (AC-Powered Alarm Bar configured as Remote)

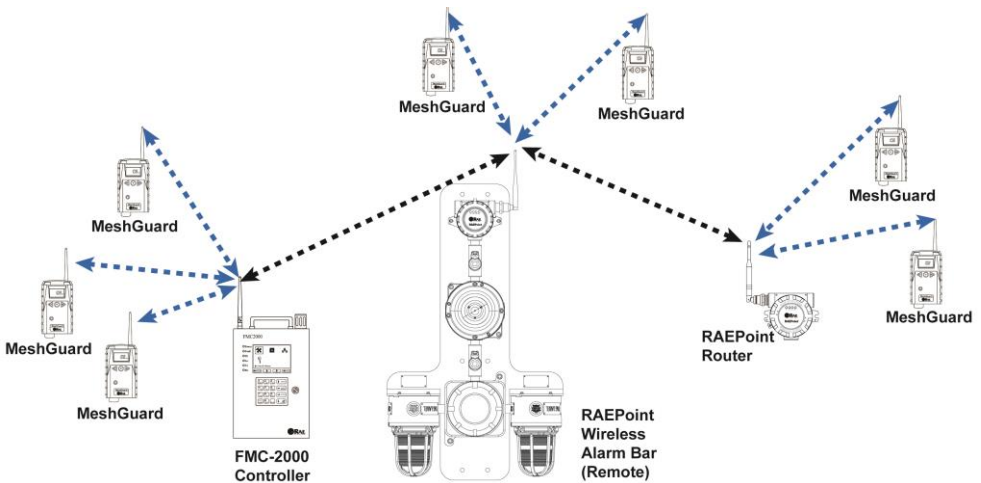

RAEPoint User's Guide

Full network, including externally controlled devices (DC-Powered Alarm Bar with RAEPoint configured as Remote)

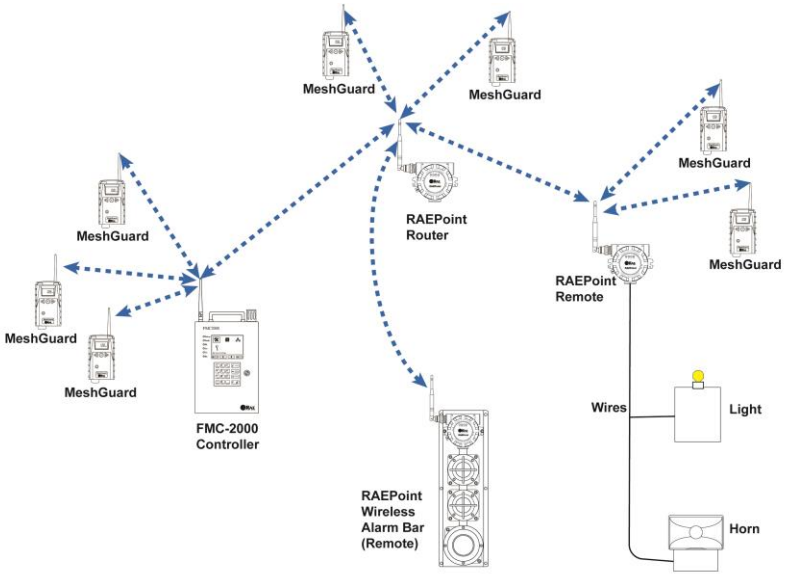

RAEPoint User's Guide

5 RAEPoint Specifications

This table covers RAEPoint only.

Input Power	Input Power Limit: 2.4W V_{input} : 12-28VDC
Output	Five 3-level programmable alarm relays (30 VDC, 2A), dry contact Resistive load Max: 6A@24VDC or 6A@250VAC Inductive load Max: 2A@24VDC or 3A@250VAC
IP Rating	IP-65
Mechanical Interface	3/4" NPT Female
Installation	2" pipe-holding or wall mounting
Operation Environment Parameters	
Temperature	-20° C to +55° C (-4° F to 131° F)
Humidity	0 to 95% relative humidity, non-condensing
Pressure	90 to 110kPa
Display	
Display	4 LEDs (Network, Alarm, Communication, Mode)
Physical Parameters	
Dimensions, L x W x H	257 x 201 x 107 mm (10.1" x 7.9" x 4.2")
Material	Alumina
Weight	3.5 kg (7.7 lbs)

Specifications subject to change.

RAEPoint User's Guide

Brazil Radio Specifications

Radio model: RM900A

Frequency range: Within 902 to 907.5 MHz and 915 to 928 MHz, use IEEE 802.15.4 channel 1, 6, 7, 8, 9 and 10

Modulation: 802.15.4 DSSS BPSK

RF power(Tx): 20dBm

Data rate: 40kbps

Radio model: RM2400A

Frequency range: 2.400 to 2.4835GHz



Modulation: 802.15.4 DSSS BPSK

RF power(Tx): 20dBm

Data rate: 250kbps

RAEPoint Hazardous Location Classification

This table includes Hazardous Location information for RAEPoint only. The Wireless Alarm Bars (AC and DC versions) used as examples in this manual do not conform to the same certifications of the RAEPoint. Refer to the corresponding Wireless Alarm Bar manuals for product specific specifications.

IECEX	ATEX	North America
IECEX SIR 12.0027X	Sira 12ATEX 1085X	
Ex d ia IIC T6, Gb	 0575  II 2G, Ex d ia IIC T6 Gb	Cl.I Div 1, Group A,B,C,D T6

Temperature range: $-20^{\circ} \text{C} \leq T_{\text{amb}} \leq 55^{\circ} \text{C}$

6 Operation

Note: Prior to factory shipment, the RAEPoint is tested. However, the instrument should be tested after installation.

RAEPoint User's Guide

7 Physical Description

The RAEPoint can be easily installed and integrated with various control systems. It is designed with flexible pipe-holding/wall-mounting options and standard connection terminals.

8 Physical Dimensions

The physical dimensions are as follows:

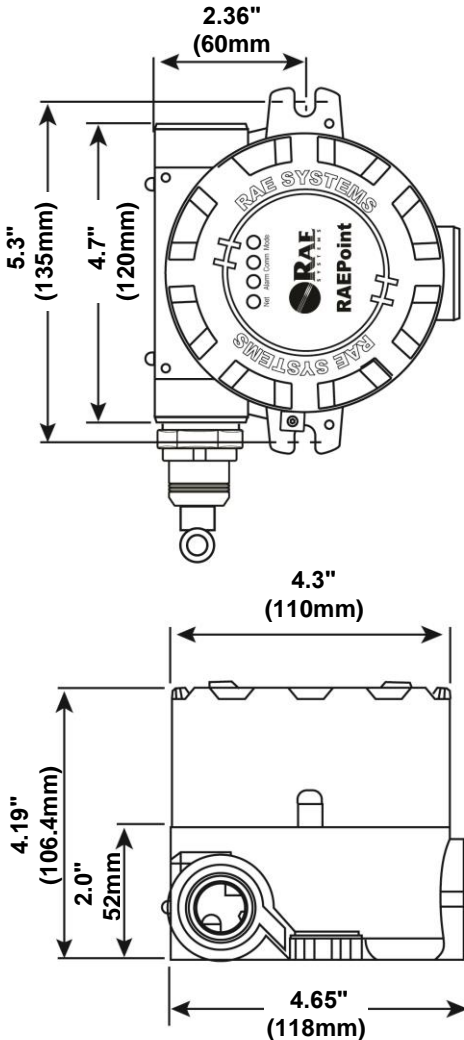

9 Installation And Access Instructions

Note: If the RAEPoint is integrated into a Wireless Alarm Bar, follow the installation and access instructions in its Installation Guide.

9.1 Mounting

First, decide where the transmitter will be mounted. (Refer to installation drawing, below.) Drill two holes in mounting surface, with the center of the holes 5.25" (135 mm) apart.

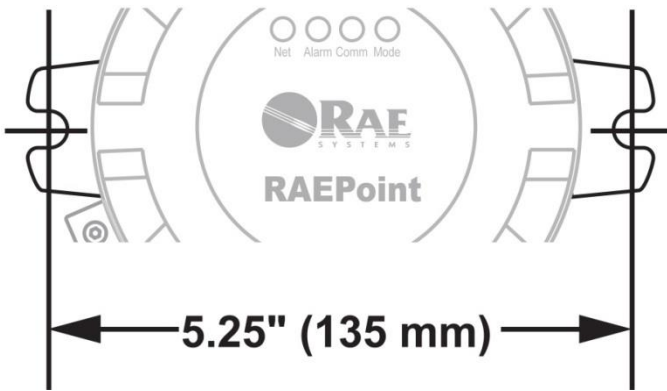

RAEPoint User's Guide

9.2 Instrument Disassembly



Prior to service: Make sure power is OFF. Observe all Hazardous Location Safety procedures.

1. Loosen the hex locking screw on the housing lid.



2. Unscrew the housing lid by rotating it counterclockwise.

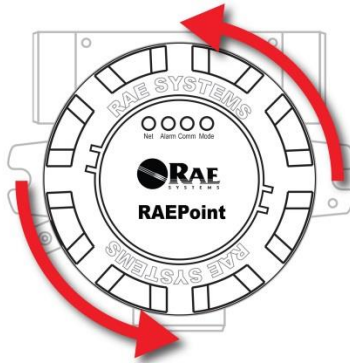

3. Press in on the clips on both sides of the display, and then lift out the circuit boards.

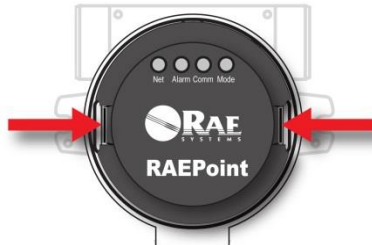

4. Turn the circuit boards over to access the switches and wiring points. Be careful not to damage the antenna wire between

RAEPoint User's Guide

10 RAEPoint Wiring

The two terminal blocks in the RAEPoint accept 12AWG to 24AWG wire. One terminal block is for DC power, and the other is for relay connections. **Note:** Refer to the RAEPoint Wireless Alarm Bar's User's Guide for information on connecting the Wireless Alarm Bar.

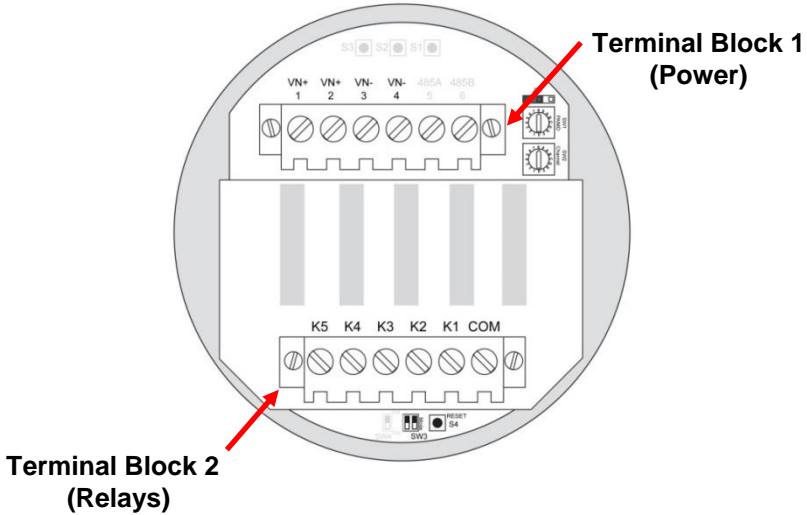

IMPORTANT!

Read this before wiring a RAEPoint to control external customized loads.

1. Before wiring a RAEPoint to control external devices, consult the datasheet that applies to the RAEPoint's relays:
http://www3.panasonic.biz/ac/e/control/relay/cautions_use/index.jsp#ANCHOR3
2. Some non-resistive loads, such as motors, horns, or strobes, may present high inrush current, causing relay contact degradation/welding even they are within the relays' rating. A simple solution is to place an NTC thermistor (for example, model B57236S0509M0** from EPCOS) in series between the relay and the load, to limit inrush current.

Note: A RAEPoint that is factory-configured as a router does not contain relays.

RAEPoint User's Guide

11 RAEPoint Wiring Procedure

Note: The following section is for wiring a stand-alone RAEPoint. If you are wiring a RAEPoint Wireless Alarm Bar, refer to the RAEPoint Wireless Alarm Bar Installation Guide.

1. Inside the housing bottom, two green terminal block plugs are inserted into the terminal blocks on the PC boards.

The terminal block plugs accept 12 AWG to 24 AWG wire.

Note: On the RAEPoint Wireless Alarm Bar, wiring from the Relay outputs and downline power are already complete. Only Power and Ground (earth) connections need to be made. See “Earth Grounding Instructions,” page 20, for information on proper grounding.

2. Route the wires through the RAEPoint's wire hole(s) and connect wires to the corresponding pin numbers of the terminal blocks:

Terminal	Terminal Definition	Terminal	No.
Block 1	Positive DC power supply for RAEPoint	VN+	1
	Positive DC power for downline units	VN+	2
	Negative DC power supply for RAEPoint	VN-	3
	Negative DC power for downline units	VN-	4
Block 2	Relay Output 5	K5	K5
	Relay Output 4	K4	K4
	Relay Output 3	K3	K3
	Relay Output 2	K2	K2
	Relay Output 1	K1	K1
	Relay Common	COM	COM

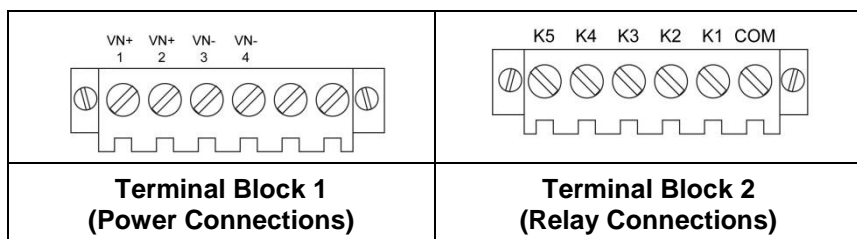

RAEPoint User's Guide

12 DC Control Wiring

When wiring the RAEPoint's relays to external devices, the resistance of the wiring may be sufficient to cause significant voltage drop, particularly in long wires. In order to compensate for this, you must calculate the resistance and compensate accordingly.

The table below gives approximate values for resistance by wire gauge (AWG). After calculating and compensating for voltage drop, check the system to ensure that all equipment is receiving sufficient voltage.

Wire Gauge and DC resistance values (in ohms)

AWG gauge	Ohms per 1000 ft.	Ohms per km
12	1.588	5.20864
13	2.003	6.56984
14	2.525	8.282
15	3.184	10.44352
16	4.016	13.17248
17	5.064	16.60992
18	6.385	20.9428
19	8.051	26.40728
20	10.15	33.292
21	12.8	41.984
22	16.14	52.9392
23	20.36	66.7808
24	25.67	84.1976

Voltage Loss = Amperes x Wire Resistance per 1,000 feet x Distance in thousands of feet x 2 Wires

- or -

Voltage Loss = Amperes x Wire Resistance per kilometer x Distance in kilometers x 2 Wires

RAEPoint User's Guide

13 Switch Settings

Configuration requires setting the two hexadecimal rotary-encoder switches that govern Pan ID and Channel, located inside the RAEPoint.

13.1 Pan ID (SW1) And Channel (SW2)

Make sure all units in the network, including an FMC2000 controller and any monitors, have the same Pan ID number and channel in order to communicate within the network. If you change the Pan ID number or Channel on the FMC2000, check the other units in the network, as well as the RAEPoint, to ensure they match.

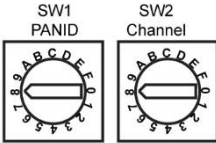

Use a small-blade screwdriver to turn each rotary encoder to the proper value.

The following chart shows settings for the two encoders:

SW1	0	1	2	3	4	5	6	7	8	9	A	B	C	D	E	F
PAN ID	999	998	997	996	995	994	993	992	991	990	989	988	987	986	985	984
SW2	0	1	2	3	4	5	6	7	8	9	A	B	C	D	E	F
Channel (ISM)	Ch0	Ch1	Ch3	Ch5	Ch6	Ch7	Ch8	Ch10	Ch15	Ch16	Ch17	Ch18	Ch19	Ch20	Ch25	Ch26
	868 MHz	902 to 928 MHz						2.4 GHz								

IMPORTANT!

Available channels vary by the internal wireless modem's frequency.

The channel can only be set to one that is available for the wireless modem frequency of your RAEPoint. For example, a RAEPoint with a 2.4 GHz modem can only use channels shown (15, 16, 17, 18, 19, 20, 25, 26).

Note: After you change the settings on the rotary encoders, press the Reset button (labeled S4).

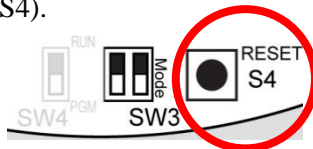

RAEPoint User's Guide

13.2 Mode Switch (SW3)

Two DIP switches, labeled SW3, can be used to change the RAEPoint's mode of operation (Host, Remote, or Router). The RAEPoint's mode was set at the factory, but if you need to reconfigure it, set the switches as follows:

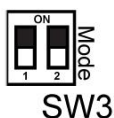

Switch 1	Switch 2	Mode
On	On	RAEPoint Host
On	Off	RAEPoint Remote
Off	On	RAEPoint Router
Off	Off	Factory Setting*

Factory settings are indicated by the RAEPoint's serial number:

- F081 RAEPoint Remote
- F082 RAEPoint Router
- F083 RAEPoint Host

Note: After you change the settings on the two DIP switches, press the Reset button (labeled S4).

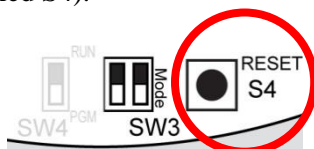

RAEPoint User's Guide

13.3 Jumper JP1

The jumper labeled JP1 has no effect on operation, so leave it in place, as shown:

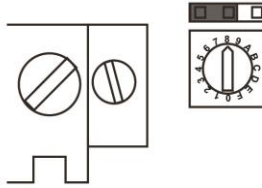

Important!

Once the system is operational, test the functionality of all connected relays.

14 Earth Grounding Instructions

14.1 External Earth Grounding

Fasten the crimped ground wire with hardware as illustrated below. The wire should have a minimum cross-section area of 4mm^2 for its conductor.

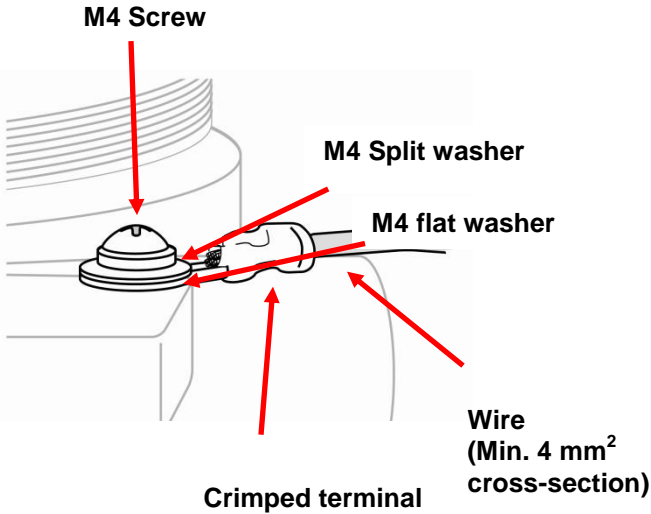

14.2 Internal Earth Grounding

Use the same hardware as shown in the illustration of external earth grounding. The wire should be no less than the size of the power lines. Signal grounding can connect to a cable's shielding layer if shielded cable is used. If a separate wire is used for grounding, its cross section should be greater than that of the power line.

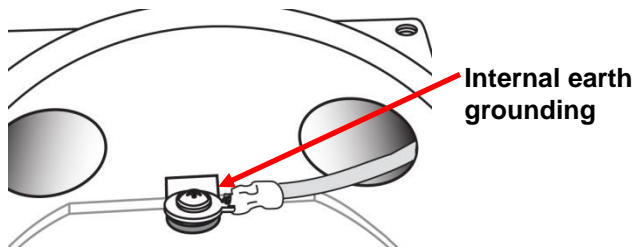

RAEPoint User's Guide

14.3 Finished Grounding Wires

Internal and external grounding are shown here, as well as an alternate external grounding point. Always follow local electrical guidelines.

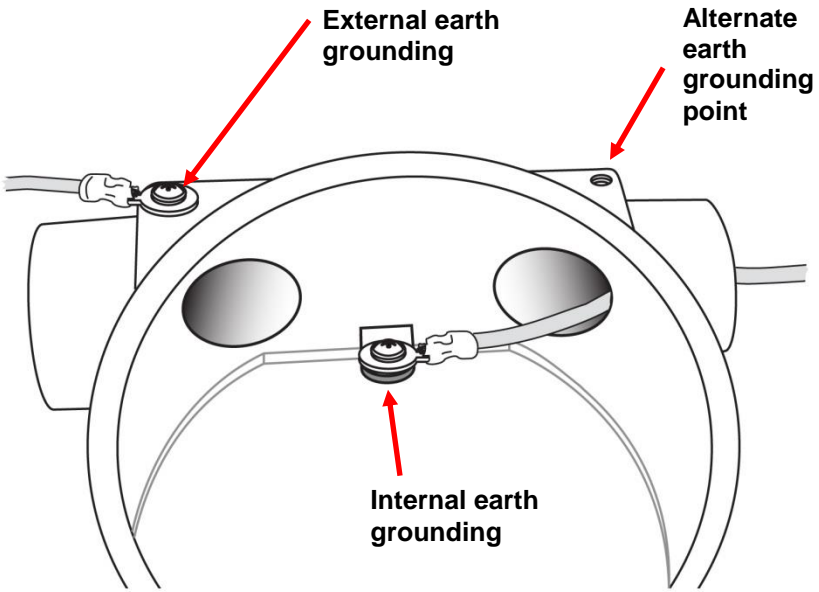

RAEPoint User's Guide

15 Display/User Interface

The RAEPoint's user interface consists of four status LEDs. There are no buttons or controls. All settings are made internally.

16 Alarm Signal Summary

The following are reading-related alarms.

	Function	Host	Remote	Router
Net	Network Status Indicator	<ul style="list-style-type: none"> • Blinks once per second if in network. • Off when there is no network 		
Alarm	Alarm Type Indicator	<ul style="list-style-type: none"> • On during any relay action • Blinks for any fault 	<ul style="list-style-type: none"> • On during any relay action • Blinks for any fault 	Blinks for any fault
Comm	Communications Activity Indicator	<ul style="list-style-type: none"> • Blinks for all communication • Off at any other time 		
Mode	Device Type Indicator	On	Blinks once per second	Blinks twice per second

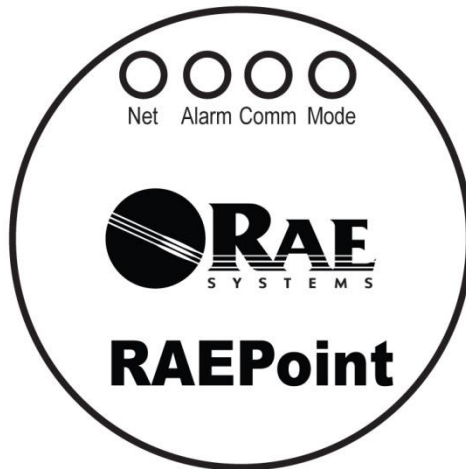

RAEPoint User's Guide

16.1 RAEPoint Host

The LEDs on the RAEPoint Host indicate the following conditions:

Net	<ul style="list-style-type: none">• Blinks when a network is established.• Off when a network is absent.
Alarm	<ul style="list-style-type: none">• Glows solid red when detectors are in alarm• Blinks red when detectors have a fault.• Blinks red when DC supply voltage is below 11 volts.
Comm	<ul style="list-style-type: none">• Flashes when there is RF (radio frequency) send/receive activity.
Mode	<ul style="list-style-type: none">• Glows solid green.

Notes

Relay Definitions:	Relay 1	Any alarms
	Relay 2	Any low alarms
	Relay 3	Any high alarms
	Relay 4	High LEL alarms
	Relay 5	High H2S alarms

IMPORTANT! This is a fixed configuration and cannot be modified.

RAEPoint User's Guide

16.2 RAEPoint Remote

Note: RAEPoint Remote can only operate with an FMC2000 Controller.

The LEDs on the RAEPoint Remote indicate the following conditions:

Net	<ul style="list-style-type: none">• Blinks when a network is established.• Off when a network is absent.
Alarm	<ul style="list-style-type: none">• Glows solid red when detectors are in alarm• Blinks red when DC supply voltage is below 11 volts.
Comm	<ul style="list-style-type: none">• Flashes when there is RF (radio frequency) send/receive activity.
Mode	<ul style="list-style-type: none">• Blinks one time per second (green).

Notes

Relay Definitions: The relays in the RAEPoint mirror the relays in the FMC2000 Controller on the same network. Definitions are set at the FMC2000 Controller.

RAEPoint User's Guide

16.3 RAEPoint Router

Note: A RAEPoint Router can operate as a router for any device using the same radio type.

The LEDs on the RAEPoint Router indicate the following conditions:

Net	<ul style="list-style-type: none">• Blinks when a network is established.• Off when a network is absent.
Alarm	<ul style="list-style-type: none">• Blinks red when DC supply voltage is below 11 volts.
Comm	<ul style="list-style-type: none">• Flashes when there is RF (radio frequency) send/receive activity.
Mode	<ul style="list-style-type: none">• Blinks two times per second (green).

Note: RAEPoint purchased as a router does not contain relays.

17 Appendix A: Controlled Section

This section applies to the RAEPoint only. Information for the RAEPoint Wireless Alarm Bar is included in section 16.

17.1 Scope

The scope of this document is to identify the section of the RAEPoint controlled part of the manual.

17.2 Responsibility

The included sections cannot be changed without prior approval from the Notified Body.

17.3 Contents

Below are the sections controlled by the Notified Body, including all safety-related information in the manual.

Controlled sections are:

1. Warnings and directive information
2. Marking of the RAEPoint
3. Hazardous Location Classifications
4. Instructions for Safe Use
5. Connections and Ratings
6. Maintenance
7. Physical dimensions

RAEPoint User's Guide

1. Warnings And Directive Information

- READ BEFORE OPERATING -

This manual must be carefully read by all individuals who have or will have the responsibility of using, maintaining, or servicing this product. The product will perform as designed only if it is used, maintained, and serviced in accordance with the manufacturer's instructions.

CAUTION!



To reduce the risk of electric shock, turn the power off before removing the instrument cover. Disconnect the power before removing the sensor module for service. Never operate the instrument when the cover is removed. Remove instrument cover and sensor module only in an area known to be non-hazardous.



Use of non-RAE Systems components will void the warranty and can compromise the safe performance of this product.

WARNING!

Wireless communication is intended for use as a secondary remote alarm status notification only. Primary alarming of combustible gas hazards is provided locally by the detector.

RAEPoint User's Guide



2. Marking Of RAEPoint

RAEPoint is certified according to ATEX and the IECEx scheme and CSA for US and Canada as protected by a flameproof enclosure, and the antenna barrier is used on intrinsically safe principles.

The product is marked with the following information:

RAE Systems Inc.
3775 N. 1st. St.
San Jose, CA95134 USA
Serial number: XXXXXXXXXXXX
Year of production

RAEPoint

IECEX	ATEX	North America
IECEX SIR 12.0027X	Sira 12ATEX 1085X	Cl.I Div 1, Group A,B,C,D T6
Ex d ia IIC T6, Gb	 0575  II 2G, Ex d ia IIC T6 Gb	

Temperature range: $-20^{\circ}\text{C} \leq T_{\text{amb}} \leq 55^{\circ}\text{C}$

WARNING: READ USER'S MANUAL FOR SAFETY PRECAUTIONS.

WARNING: DO NOT OPEN WHEN AN EXPLOSIVE ATMOSPHERE MAY BE PRESENT.

REFER TO USER MANUAL FOR ENTRY TYPE AND SIZE.

RAEPoint User's Guide

3. Hazardous Location Classification

Hazardous Areas Classified By Zones

RAEPoint is intended to be used in hazardous areas classified for Zone 1 or Zone 2, within the temperature range of -20°C to $+55^{\circ}\text{C}$, where gases of explosion groups IIA, IIB or IIC and T6 may be present.

Hazardous Areas Classified By Divisions

RAEPoint is intended to be used in hazardous areas classified for Class I Div. 1 or 2, within the temperature range of -20°C to $+55^{\circ}\text{C}$, where gases of explosion groups A, B, C or D and temperature class T6 may be present.

4. Instructions For Safe Use

The threaded coaxial connector external to the enclosure shall only be fitted with a dedicated antenna and shall not be used to supply an external, intrinsically safe circuit.

5. Connections And Ratings

Input/Output

The rated RAEPoint input/output are as follows:

Input: 2.4W V_{input} : 12-28VDC

6. Maintenance

Installation and Access Instructions

- An explosion-proof seal is required for all gas groups within 18" (46 cm) of the enclosure. The appropriate regulations for installation, service and repair must be properly observed during such activities.
- To prevent ignition of hazardous atmospheres, area must be free of flammable vapors and supply circuit must be disconnected before removing cover.

WARNING

Negative terminal of power supply must be grounded.

RAEPoint User's Guide

Earth Grounding Instructions

External Earth Grounding

Fasten the crimped ground wire with hardware as illustrated here. The wire should have a minimum cross-section area of 4mm^2 for its conductor.

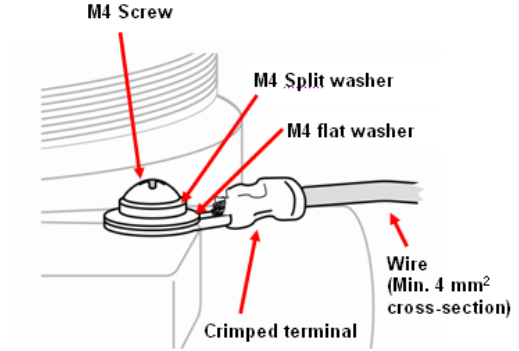

Internal Earth Grounding

Use the same hardware as shown in the illustration of external earth grounding. The wire should be no less than the size of the power lines.

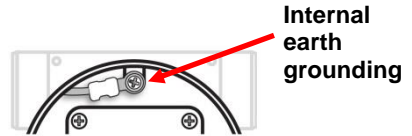

Finished Grounding Wires

Internal and external grounding are shown here, as well as an alternate external grounding point. Always follow local electrical guidelines.

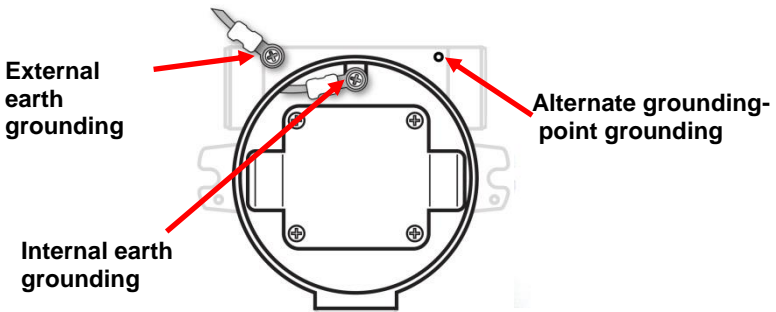

RAEPoint User's Guide

7. Physical Dimensions

RAEPoint can be easily installed and integrated with various control systems with its flexible pipe-holding/wall-mounting options and standard connection terminals.

Entries: RAEPoint is provided with three female 3/4" - 14 NPT cable entry holes tapped into its side walls; one 3/4" - 14 NPT containing the antenna coupler for mounting of the external antenna.

The physical dimensions are as follows:

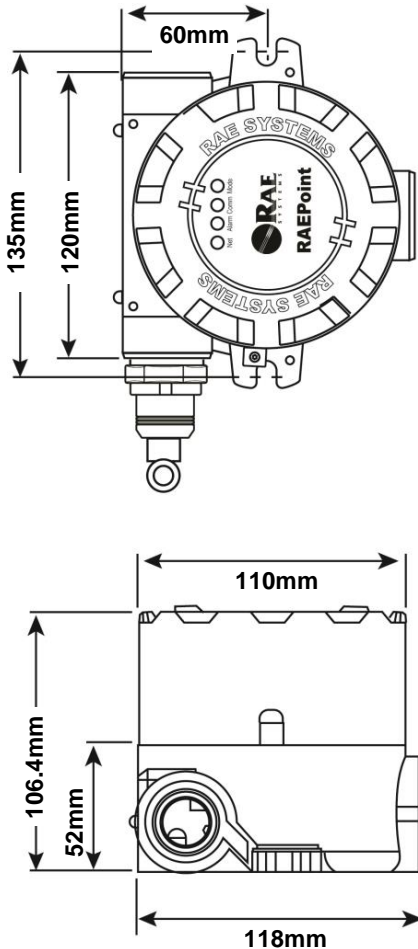

RAEPoint User's Guide

8. Models Of RAEPoint

Model Number	Product Name
RRA2000	RAEPoint Wireless Switch Remote
RRA2000	RAEPoint Wireless Router
RRA2000	RAEPoint Wireless Switch Host / RAEPoint GateWay

18 Technical Support

To contact RAE Systems Technical Support:

Monday through Friday, 7:00AM to 5:00PM Pacific (US) Time

Phone (toll-free): +1 888-723-4800

Phone: +1 408-952-8461

Email: tech@raesystems.com

19 RAE Systems Contacts

RAE Systems by Honeywell

World Headquarters

3775 N. First St.

San Jose, CA 95134-1708 USA

Phone: +1 408.952.8200

Fax: +1 408.952.8480

E-mail: customerserv@raesystems.com

Web Site: www.raesystems.com

RAE Systems Technical Support

Monday through Friday, 7:00AM to 5:00PM Pacific Time

Phone: +1.408.952.8461

Email: tech@raesystems.com

RAEPoint User's Guide

EMEAI Headquarters

Life Safety Distribution AG

Javastrasse 2

8604 Hegnau, Switzerland

Phone: +41 (0)44 943 4300

Fax: +41 (0)44 943 4398

Email: haexpert@honeywell.com

RAE Systems France

ZI des Ayats

679390 MILLERY

France

Phone: +33 4 78 46 16 65

Fax: +33 4 78 46 25 98

Phone: +33 4 78 46 16 65

Fax: +33 4 78 46 25 98

Email: info-france@raeurope.com

Web: www.raesystems.fr

RAE BeNeLux BV

Rijndal 20

2904 DC Capelle a/d IJssel

Netherlands

Phone: +31 10 4426149

Fax: +31 10 4426148

Email: info@rae.nl

Web: www.rae.nl

RAE Systems Spain, s.l.

Av. Remolar, 31

08820 El Prat de Llobregat

Spain

Phone: +34 933 788 352

Fax: +34 933 788 353

Email: info@raespain.com

Web: www.raespain.com

RAEPoint User's Guide

RAE Systems by Honeywell

Brazil Office

Av. Marginal da Rodovia dos Bandeirantes, 100 Jundiaí - SP

ZIP: 13213-008 Brazil

Phone: +55.11.3309.1030

Fax: +55.11.3309.1035

Email: HALA@honeywell.com

Web: www.raesystems.com.br

RAE Systems (Hong Kong) Ltd.

Room 8, 6/F, Hong Leong Plaza

33 Lok Yip Road

Fanling, N.T, Hong Kong

Phone: +852.2669.0828

Fax: +852.2669.0803

Email: hksales@raesystems.com

RAE Systems Japan

Marunouchi Nakadori Bldg 6F-617-B,

2-3, Marunouchi 2-Chome, Chiyoda-ku,

Tokyo, 100-0005 Japan

Phone: +81-3-6269-9646

Fax: +81-3-6269-9647

Email: jpsales@raesystems.com

RAE Systems Korea

#1010, DaeMyungAnsVill First,

Sang-Dong 412-2, Wonmi-Gu, Bucheon,

Kyungki-Do, Korea

Phone: 82-32-328-7123

Fax: 82-32-328-7127

Email: krsales@raesystems.com

CORPORATE HEADQUARTERS

RAE Systems by Honeywell

3775 North First Street

San Jose, CA 95134 USA

Phone: 408.952.8200

Fax: 408.952.8480

customerserv@raesystems.com

WORLDWIDE SALES OFFICES

USA/Canada 1.877.723.2878

EMEA +41.044.943.4300

China +86.10.5885.8788-3000

Asia Pacific +852.2669.0828